

APPLICAZIONI

Elettropompe centrifughe bigiranti per sollevare acqua pulita e liquidi moderatamente carichi di impurità non aggressivi per i materiali delle pompe. Caratteristica principale è l'impiego di due giranti contrapposte che permettono, a differenza del modello monogirante, elevate prevalenze. Adatte per impianti civili e industriali, distribuzione automatica dell'acqua a mezzo di piccoli-medi serbatoi (autoclave) e per irrigazione a pioggia in giardino e in agricoltura.

APPLICATION

Twin impeller centrifugal water pumps to lift clean water and non-aggressive liquids. The main feature are the two opposite impellers which allow higher lifts than in the single-impeller model. They are qualified for civil and industrial fittings, for water distribution by tank pressure groups and for irrigation in gardening and agriculture.

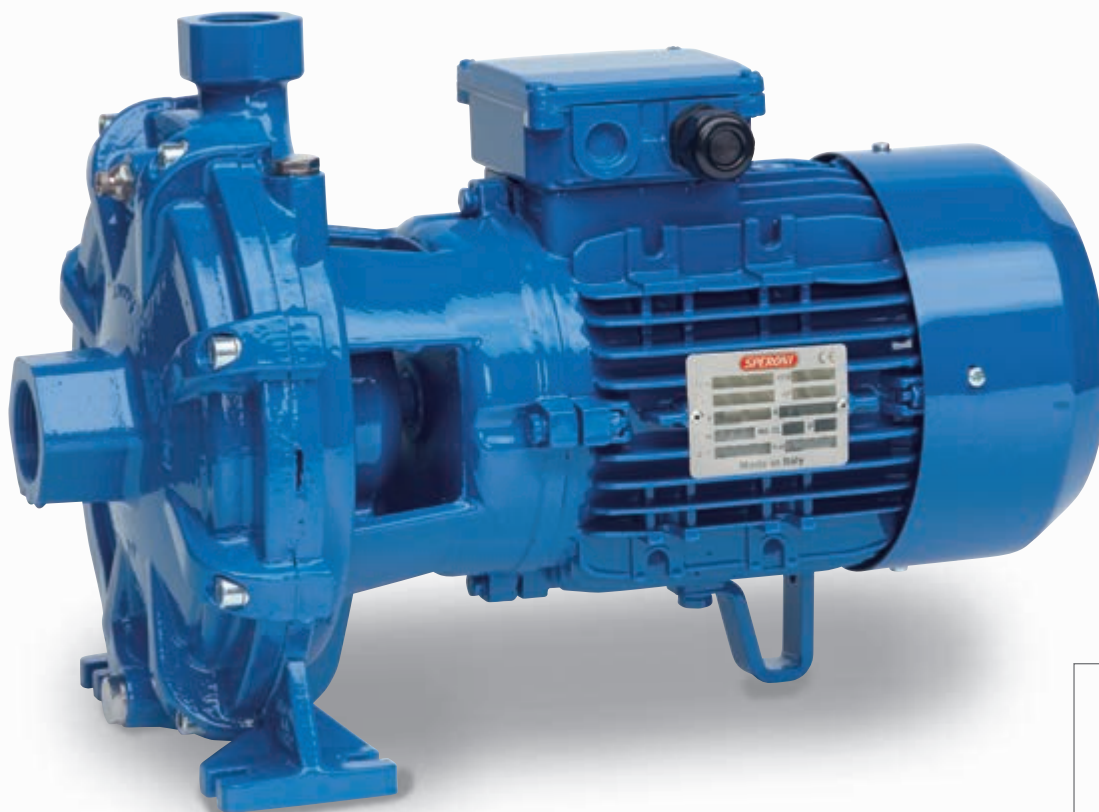

GIRANTE - IMPELLER

LIMITI D'IMPIEGO

- Temperatura liquido fino a 35°C (per un uso domestico secondo EN 60335-2-41)
- Temperatura max. liquido: 90°C (per altri impieghi)
- Temperatura ambiente fino a 40°C
- Altezza d'aspirazione manometrica fino a 7 mt.
- Servizio continuo

MOTORE

- Monofase 230V-50Hz
- Trifase 230/400V-50Hz $P_2 \leq 7,5$ kW
- Trifase 400/690V-50Hz $P_2 > 7,5$ kW
- Motore elettrico ad induzione a 2 poli ($n = 2850$ min⁻¹)
- Isolamento Classe F
- Protezione IP 55

MATERIALI

- | | |
|---------------------|-----------------------|
| - Corpo pompa | Ghisa |
| - Supporto motore | Ghisa |
| - Giranti | Ottone |
| - Albero motore | Acciaio Inox AISI 304 |
| - Tenute meccaniche | Ceramica/Grafite/NBR |

OPERATING CONDITIONS

- Liquid temperature up to 35°C (for home use according to EN 60335-2-41)
- Temperature max. liquid: 90°C (for other uses)
- Ambient temperature up to 40°C
- Total suction lift up to 7 mt.
- Continuous duty

MOTOR

- Single-phase 230V-50Hz
- Three-phase 230/400V-50Hz $P_2 \leq 7,5$ kW
- Three-phase 400/690V-50Hz $P_2 > 7,5$ kW
- Two-Pole induction motor ($n = 2850$ min⁻¹)
- Insulation Class F
- Protection IP 55

MATERIALS

- | | |
|--------------------|--------------------------|
| - Pump body | Cast Iron |
| - Motor Support | Cast Iron |
| - Impellers | Brass |
| - Shaft with rotor | Stainless Steel AISI 304 |
| - Mechanical seal | Ceramic/Graphite/NBR |

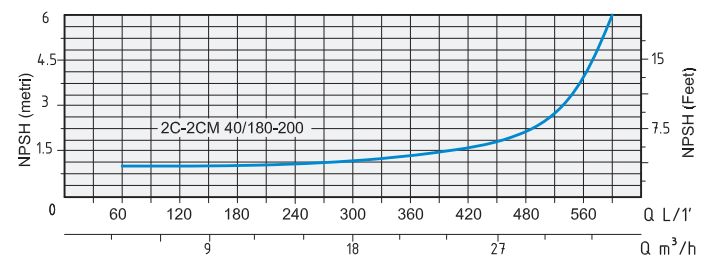
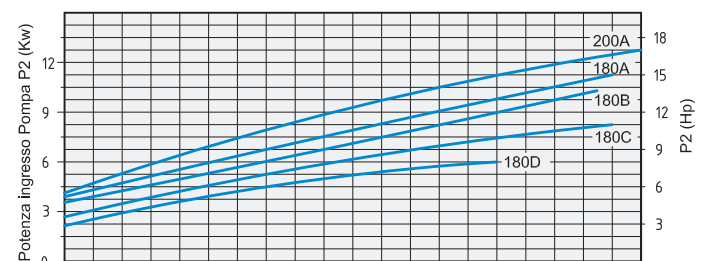
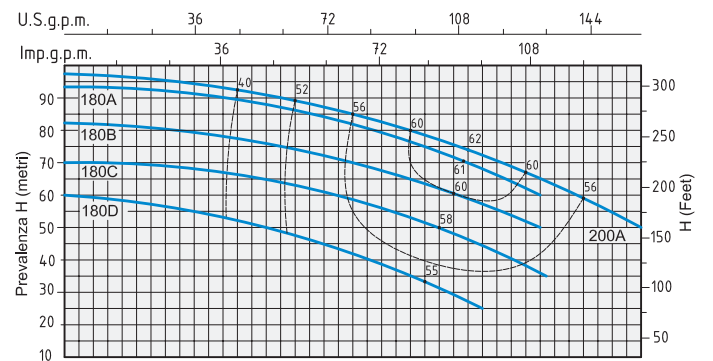
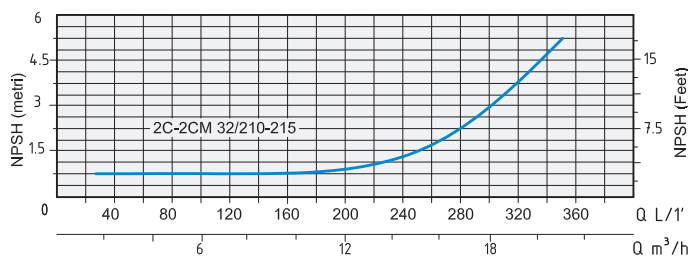
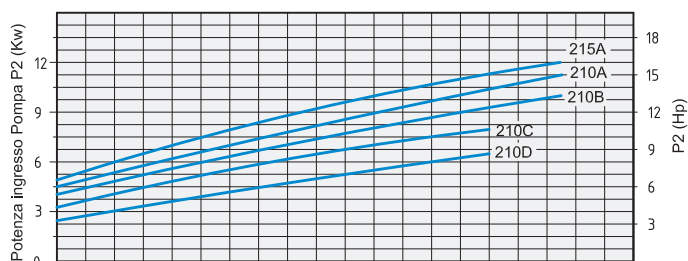
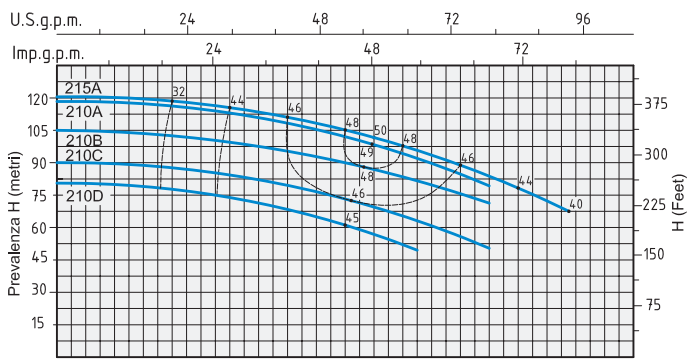
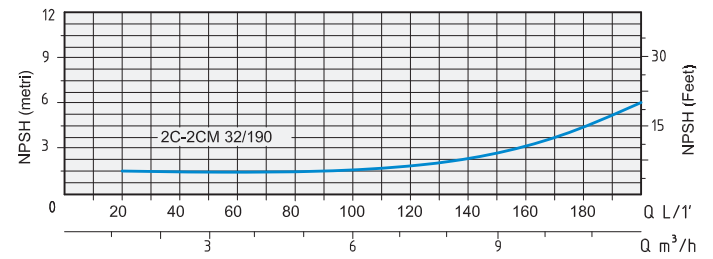
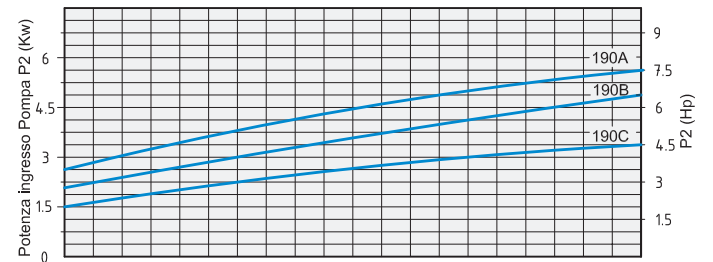
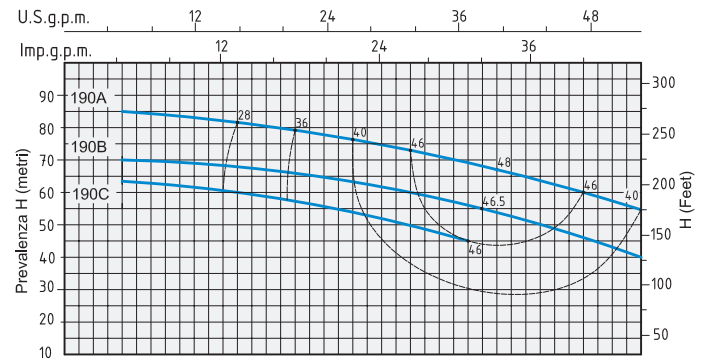
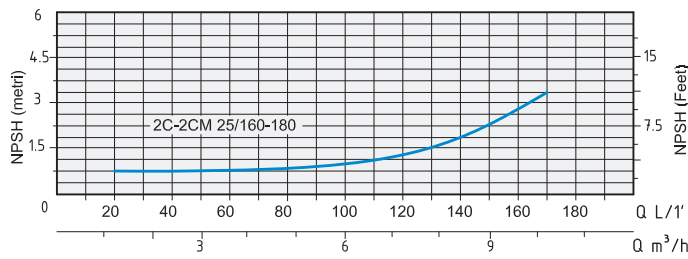
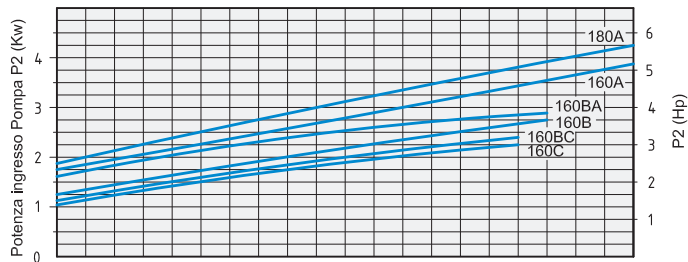
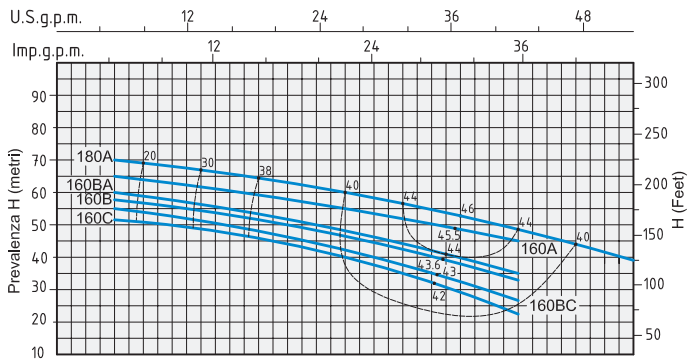

TWIN IMPELLER CENTRIFUGAL PUMPS

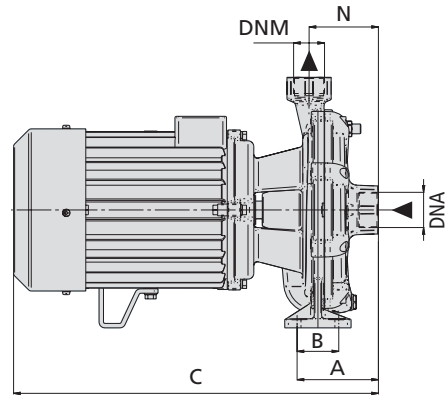
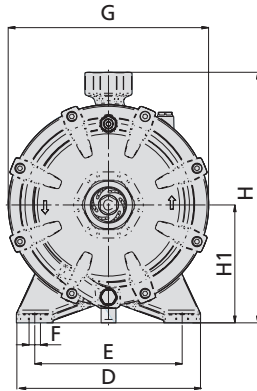

TIPO TYPE		DIMENSIONI mm - DIMENSIONS mm												DIMENSIONI DIMENSIONS mm			PESO WEIGHT
Monofase Single-phase	Trifase Three-phase	A	B	C	D	E	F	G	H	H1	N	DNA	DNM	P	L	H	Kg
2CM 25/160C	2C 25/160C	95	50	400	208	168	10	222	265	120	85	1" 1/4	1"	240	414	314	24,6
		95	50	432	208	168	10	222	265	120	85	1" 1/4	1"	240	414	314	26,4
	2C 25/160B	95	50	432	208	168	10	222	265	120	85	1" 1/4	1"	240	414	314	24,6
2CM 25/160BA	2C 25/160BA	95	46	432	208	168	10	222	265	120	85	1" 1/4	1"	259	507	345	29,9
2CM 25/160A	2C 25/160A	108,5	46	440	230	190	12	246	290	132	92,5	1" 1/4	1"	259	507	345	36,1
	2C 25/180A	108,5	46	440	230	190	12	246	290	132	92,5	1" 1/4	1"	310	530	460	35,9

TIPO TYPE		DIMENSIONI mm - DIMENSIONS mm												DIMENSIONI DIMENSIONS mm			PESO WEIGHT
Monofase Single-phase	Trifase Three-phase	A	B	C	D	E	F	G	H	H1	N	DNA	DNM	P	L	H	Kg
2CM 32/190C	2C 32/190C	120	60	450	250	200	15	272	340	160	94	1" 1/2	1" 1/4	310	530	460	40,7
	2C 32/190B	120	60	485	250	200	15	272	340	160	94	1" 1/2	1" 1/4	310	530	460	44,9
2CM 32/190A	2C 32/190A	120	60	495	250	200	15	272	340	160	94	1" 1/2	1" 1/4	310	530	460	53,9

TIPO TYPE		DIMENSIONI mm - DIMENSIONS mm												DIMENSIONI DIMENSIONS mm			PESO WEIGHT
Monofase Single-phase	Trifase Three-phase	A	B	C	D	E	F	G	H	H1	N	DNA	DNM	P	L	H	Kg
2CM 32/210D	2C 32/210D	121	60	530	280	225	15	300	375	160	107	2"	1" 1/4	342	620	475	60
	2C 32/210C	121	60	575	280	225	15	300	375	160	107	2"	1" 1/4	342	620	475	70,6
	2C 32/210B	121	60	575	280	225	15	300	375	160	107	2"	1" 1/4	342	620	475	75,4
	2C 32/210A	121	60	575	280	225	15	300	375	160	107	2"	1" 1/4	372	805	550	91,1
	2C 32/215A	121	60	612	280	225	15	300	375	160	107	2"	1" 1/4	372	805	550	96,1

TIPO TYPE		DIMENSIONI mm - DIMENSIONS mm												DIMENSIONI DIMENSIONS mm			PESO WEIGHT
Monofase Single-phase	Trifase Three-phase	A	B	C	D	E	F	G	H	H1	N	DNA	DNM	P	L	H	Kg
2CM 40/180D	2C 40/180D	126	60	535	280	225	15	300	375	160	116	2"	1" 1/2	342	620	475	60,9
	2C 40/180C	126	60	580	280	225	15	300	375	160	116	2"	1" 1/2	342	620	475	71,2
	2C 40/180B	126	60	580	280	225	15	300	375	160	116	2"	1" 1/2	342	620	475	72,6
	2C 40/180A	126	60	580	280	225	15	300	375	160	116	2"	1" 1/2	372	805	550	94,1
	2C 40/200A	126	60	612	280	225	15	300	375	160	116	2"	1" 1/2	372	805	550	97,1