

Damper actuator for adjusting dampers in technical building installations

- Air damper size up to approx. 3.2 m²
- Torque motor 16 Nm
- Nominal voltage AC 100...240 V
- Control Open/close, 3-point
- Running time motor 20 s



Technical data

Electrical data	Nominal voltage	AC 100...240 V
	Nominal voltage frequency	50/60 Hz
	Nominal voltage range	AC 85...265 V
	Power consumption in operation	4.5 W
	Power consumption in rest position	1 W
	Power consumption for wire sizing	8 VA
	Power consumption for wire sizing note	Imax 4 A @ 5 ms
	Connection supply / control	Cable 1 m, 3 x 0.75 mm ²
	Parallel operation	Yes (note the performance data)
Functional data	Torque motor	16 Nm
	Direction of motion motor	selectable with switch 0 (ccw rotation) / 1 (cw rotation)
	Manual override	with push-button, can be locked
	Angle of rotation	Max. 95°
	Angle of rotation note	can be limited on both sides with adjustable mechanical end stops
	Running time motor	20 s / 90°
	Sound power level, motor	55 dB(A)
	Mechanical interface	Universal shaft clamp reversible 10...20 mm
	Position indication	Mechanically, pluggable
Safety data	Protection class IEC/EN	II, reinforced insulation
	Protection class UL	II, reinforced insulation
	Degree of protection IEC/EN	IP54
	Degree of protection NEMA/UL	NEMA 2
	Enclosure	UL Enclosure Type 2
	EMC	CE according to 2014/30/EU
	Low voltage directive	CE according to 2014/35/EU
	Certification IEC/EN	IEC/EN 60730-1 and IEC/EN 60730-2-14
	UL Approval	cULus according to UL60730-1A, UL60730-2-14 and CAN/CSA E60730-1 The UL marking on the actuator depends on the production site, the device is UL-compliant in any case
	Mode of operation	Type 1
	Rated impulse voltage supply / control	4 kV
	Pollution degree	3
	Ambient humidity	Max. 95% RH, non-condensing
	Ambient temperature	-30...50°C [-22...122°F]
	Storage temperature	-40...80°C [-40...176°F]
Servicing	maintenance-free	

Weight	Weight	1.0 kg
---------------	--------	--------

Safety notes

- This device has been designed for use in stationary heating, ventilation and air-conditioning systems and must not be used outside the specified field of application, especially in aircraft or in any other airborne means of transport.
- Outdoor application: only possible in case that no (sea) water, snow, ice, insulation or aggressive gases interfere directly with the device and that it is ensured that the ambient conditions remain within the thresholds according to the data sheet at any time.
- Caution: Power supply voltage!
- Only authorised specialists may carry out installation. All applicable legal or institutional installation regulations must be complied during installation.
- The device may only be opened at the manufacturer's site. It does not contain any parts that can be replaced or repaired by the user.
- Cables must not be removed from the device.
- To calculate the torque required, the specifications supplied by the damper manufacturers concerning the cross-section, the design, the installation situation and the ventilation conditions must be observed.
- The device contains electrical and electronic components and must not be disposed of as household refuse. All locally valid regulations and requirements must be observed.

Product features

Simple direct mounting	Simple direct mounting on the damper shaft with a universal shaft clamp, supplied with an anti-rotation device to prevent the actuator from rotating.
Manual override	Manual override with push-button possible (the gear train is disengaged for as long as the button is pressed or remains locked).
Adjustable angle of rotation	Adjustable angle of rotation with mechanical end stops.
High functional reliability	The actuator is overload protected, requires no limit switches and automatically stops when the end stop is reached.

Accessories

Electrical accessories	Description	Type
	Auxiliary switch 1 x SPDT add-on	S1A
	Auxiliary switch 2 x SPDT add-on	S2A
	Feedback potentiometer 140 Ω add-on	P140A
	Feedback potentiometer 200 Ω add-on	P200A
	Feedback potentiometer 500 Ω add-on	P500A
	Feedback potentiometer 1 kΩ add-on	P1000A
	Feedback potentiometer 2.8 kΩ add-on	P2800A
	Feedback potentiometer 5 kΩ add-on	P5000A
	Feedback potentiometer 10 kΩ add-on	P10000A

Mechanical accessories
Description
Type

Actuator arm for standard shaft clamp (reversible)	AH-20
Shaft extension 240 mm Ø20 mm for damper shaft Ø 12...21 mm CrNi	AV12-25-I
Shaft extension 240 mm Ø20 mm for damper shaft Ø 8...22.7 mm	AV8-25
Ball joint suitable for damper crank arm KH8, Multipack 10 pcs.	KG8
Ball joint suitable for damper crank arm KH8 / KH10, Multipack 10 pcs.	KG10A
Damper crank arm Slot width 8.2 mm, clamping range Ø10...18 mm	KH8
Shaft clamp one-sided, clamping range Ø8...26 mm, Multipack 20 pcs.	K-ENSA
Shaft clamp one-sided, clamping range Ø12...26 mm, for CrNi shaft (INOX), Multipack 20 pcs.	K-ENSA-I
Shaft clamp reversible, clamping range Ø10...20 mm	K-SA
Anti-rotation mechanism 230 mm, Multipack 20 pcs.	Z-ARS230
Form fit insert 10x10 mm, Multipack 20 pcs.	ZF10-NSA
Form fit insert 12x12 mm, Multipack 20 pcs.	ZF12-NSA
Form fit insert 15x15 mm, Multipack 20 pcs.	ZF15-NSA
Form fit insert 16x16 mm, Multipack 20 pcs.	ZF16-NSA
Mounting kit for linkage operation for flat installation	ZG-SMA
Position indicator, Multipack 20 pcs.	Z-PI
Base plate extension for SM..A to SM../AM../SMD24R	Z-SMA

Electrical installation

Caution: Power supply voltage!

Parallel connection of other actuators possible. Observe the performance data.

Wiring diagrams

AC 230 V, open/close

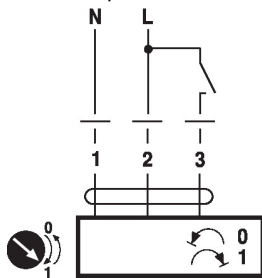
Cable colours:

- 1 = blue
- 2 = brown
- 3 = white

AC 230 V, 3-point

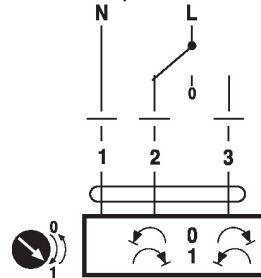

Cable colours:

- 1 = blue
- 2 = brown
- 3 = white

Dimensions
Spindle length

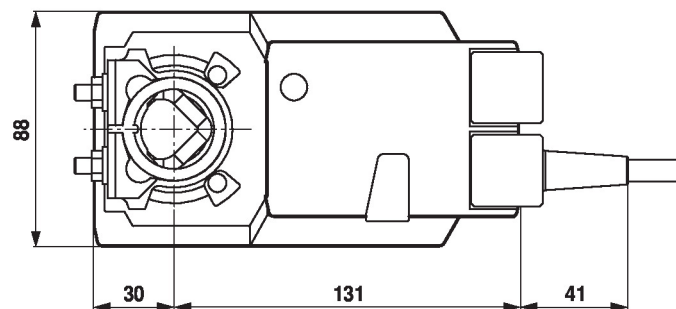
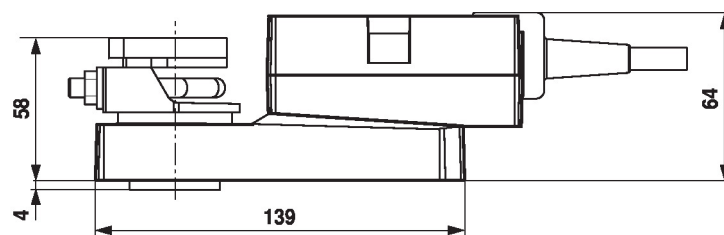
	Min. 48
	Min. 20

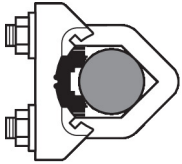

Clamping range

10 ... 20 mm

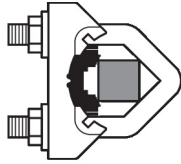
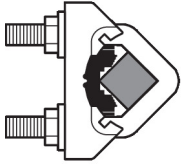
 ≥ 10 mm ≤ 20 mm

When using a round shaft made of CrNi
(INOX): \varnothing 12...20 mm